

Methods for measuring acoustic power of an ultrasonic neurosurgical device

Petošić, Antonio; Ivančević, Bojan; Svilar, Dragoljub; Štimac, Tihomir; Paladino, Josip; Orešković, Darko; Jurjević, Ivana; Klarica, Marijan

Source / Izvornik: **Collegium Antropologicum, 2011, 35, 107 - 113**

Journal article, Published version

Rad u časopisu, Objavljena verzija rada (izdavačev PDF)

Permanent link / Trajna poveznica: <https://um.nsk.hr/um:nbn:hr:105:336228>

Rights / Prava: [In copyright](#)/[Zaštićeno autorskim pravom.](#)

Download date / Datum preuzimanja: **2024-07-07**



Repository / Repozitorij:

[Dr Med - University of Zagreb School of Medicine
Digital Repository](#)



Methods for Measuring Acoustic Power of an Ultrasonic Neurosurgical Device

Antonio Petošić¹, Bojan Ivančević¹, Dragoljub Svilar², Tihomir Štimac², Josip Paladino³, Darko Orešković⁴, Ivana Jurjević⁵ and Marijan Klarica⁵

¹ University of Zagreb, Faculty of Electrical Engineering and Computing, Zagreb, Croatia

² Brodarski Institute, Zagreb, Croatia

³ University of Zagreb, Zagreb University Hospital Center, Department of Neurosurgery, Zagreb, Croatia

⁴ »Ruder Bošković« Institute, Zagreb, Croatia

⁵ University of Zagreb, Center for Clinical Research in Neuroscience and Croatian Institute for Brain Research, Zagreb, Croatia

ABSTRACT

Measurement of the acoustic power in high-energy ultrasonic devices is complex due to occurrence of the strong cavitation in front of the sonotrode tip. In our research we used three methods for characterization of our new ultrasonic probe for neuroendoscopic procedures. The first method is based on the electromechanical characterization of the device measuring the displacement of the sonotrode tip and input electrical impedance around excitation frequency with different amounts of the applied electrical power. The second method is based on measuring the spatial pressure magnitude distribution of an ultrasound surgical device produced in an anechoic tank. The acoustic reciprocity principle is used to determine the derived acoustic power of equivalent ultrasound sources at frequency components present in the spectrum of radiated ultrasonic waves. The third method is based on measuring the total absorbed acoustic power in the restricted volume of water using the calorimetric method. In the electromechanical characterization, calculated electroacoustic efficiency factor from equivalent electrical circuits is between 40–60%, the same as one obtained measuring the derived acoustic power in an anechoic tank when there is no cavitation. When cavitation activity is present in the front of the sonotrode tip the bubble cloud has a significant influence on the derived acoustic power and decreases electroacoustic efficiency. The measured output acoustic power using calorimetric method is greater than derived acoustic power, due to a large amount of heat energy released in the cavitation process.

Key words: ultrasound surgical device, sonotrode tip displacement, derived acoustic power, output acoustic power

Introduction

Successful low frequency ultrasonic systems, working in the excitation frequency range from 15 kHz to 60 kHz, for many industrial and military applications have been commercially available since the 1940s¹. In the early 1960s the use of such devices in dentistry became increasingly popular^{2–4}. In 1970 the expansion of these type of sources is seen in ophthalmology⁵. By mid 1970s, the application in neurosurgical cases firmly established the ultrasonic modality as an important surgical tool⁴. In the period from 1980 to 2000 the number of surgical specialities in which this energy source is applied has increased dramatically. This ultrasound device has traditionally been characterized using non-acoustic parameters such as displacement, frequency, and input electrical power⁶.

This approach to the characterization has originated from the industrial application of the high power ultrasonic field. Above mentioned traditional approach does not provide adequate characterization of ultrasonic devices which are used daily for medical purposes. Namely, measurement of the acoustic power absorbed in a volume of tissue is a big problem because the strong cavitation effect which causes the tissue destruction is produced in the front of the sonotrode tip^{7–10}. The ultrasonic low-frequency surgical devices can be characterized according to the IEC 6147 Standard⁷ by using one of the three available methods. These three methods are: the method for measuring the sonotrode tip displacement, the method for measuring derived acoustic power in the anechoic

tank, and the method for calorimetric determination of the output acoustic power.

Contrary to the traditional approach, in which only one method for measuring acoustic power of ultrasonic source is used, in this research we have compared the results obtained using all three methods for characterization of acoustic power of originally developed neurosurgical ultrasound probe »NECUP-2« (Neurosurgical Endoscopic Contact Ultrasonic Probe)¹². In addition, we tried to find out which of the available methods is the most appropriate for quick and easy characterization of an ultrasonic device⁹.

Material and Methods

NECUP-2 consists of an ultrasound generator and a handpiece with a surgical tip. The handpiece has a piezoceramic ring transducer. Ultrasonic source is designed as a resonant device to maximize the conversion efficiency from electrical to acoustical energy¹¹. The scheme of the transducer is shown in Fig. 1.

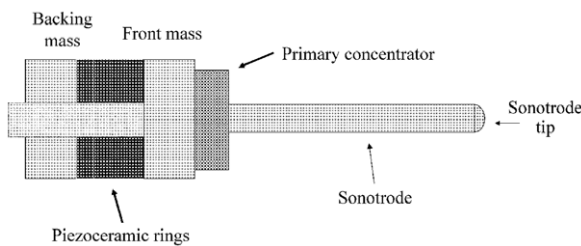

Fig. 1. Scheme of ultrasound probe used in measurements.

The sonotrode tip of NECUP-2 has a solid curved tip with a diameter of 5.0 mm. The transducer is driven at the excitation frequency $f=25$ kHz with electronic generator which enables functioning at the series resonant frequency of longitudinal vibration mode where the tip displacement has a maximal value. The voltage and the current applied on piezoceramic elements are recorded by digital oscilloscope.

Methods for measuring the acoustic power of an ultrasound surgical device

There are three methods for measuring the acoustic power of an ultrasound surgical device^{7,9}:

- 1) Electromechanical characterization of the device, measuring the sonotrode tip displacement and the input electrical impedance in the frequency range around series resonance frequency. The sonotrode tip displacement is connected to the input electrical impedance magnitude at series resonance frequency due to coupling between electrical and mechanical circuits.
- 2) Measuring the derived acoustic power in the anechoic tank using a hydrophone.
- 3) Measuring the output acoustic power with calorimetric method in the restricted volume of water.

In this research, all three methods are used for determination of the acoustic power at different electrical power levels applied. Subsequently, electroacoustic efficiency factors, calculated in three different ways, are compared.

Method for characterization of the device measuring the displacement of the sonotrode tip

Two inter-connected approaches are used in the electromechanical characterization measuring the displacement of the sonotrode tip. The first one is measuring the tip displacement (in the air and in the water) at different electrical excitation levels applied, by using an optical microscope. The second one is measuring the input electrical impedance of device around series resonant frequency at different excitation levels in the air and in the water¹⁴.

The sonotrode tip displacement measurement is based on observation of the tip oscillation using an optical microscope, measuring a movement of light spot reflected from the tip surface. The measurement setup⁷ in the air is shown in Fig. 2. The measured maximum tip displacement ξ is marked in Fig. 2. The same experiment is made in the restricted volume of water with the strong cavitation activity present in front of the tip.

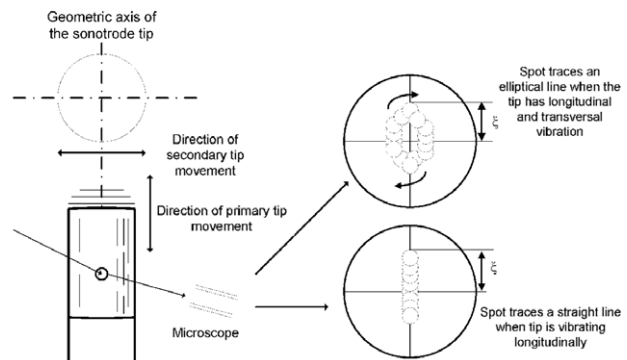

Fig. 2. Measuring the tip displacement using optical microscope.

The input electrical impedance around series resonance frequency of longitudinal vibration mode is measured when the transducer is unloaded and loaded. The transducer is unloaded when the sonotrode tip is situated in the air and it freely vibrates. The loading state is considered when the sonotrode tip is positioned in the anechoic tank at different immersion depths. The electrical scheme is shown in Fig. 3. The input electrical impedance (Z) is defined as a ratio of voltage (U) and electrical current (I) through the device:

$$Z = U/I \quad (1)$$

When the input electrical impedance magnitude (Z) has a minimal value, the displacement i.e. oscillation of the sonotrode tip is maximal and it can produce destruction of tissue. In order to calculate the coefficient of electroacoustic efficiency (η_{eaEQ}) of the device, we should

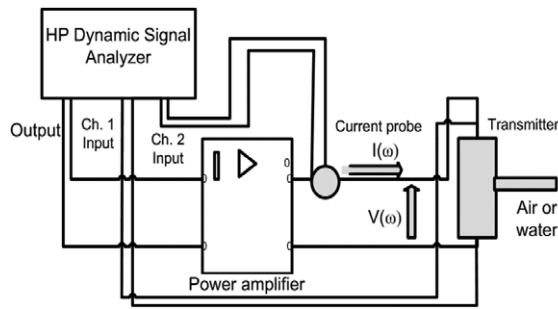

Fig. 3. Setup for measuring the input electrical impedance of an unloaded and loaded ultrasound device.

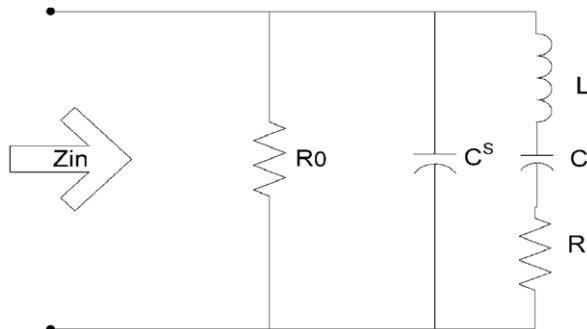

Fig. 4. Equivalent electrical circuit of the ultrasonic device.

determine the equivalent electrical circuit of the device (Fig. 4). Electroacoustic efficiency factor of the device obtained with this method is defined as a ratio of radiated acoustic power and applied electrical power of the device ($\eta_{eaEQ} = P_{rad}/P_{EL}$).

The equivalent electrical circuit (RLC) of the device is usually determined with inductivity (L), capacity (C) and resistance (R), which are measured in loaded and unloaded state of the device (see Table 1). The capacity C^S and resistance R_0 are measured at frequency of 1kHz

TABLE 1
EQUIVALENT ELECTRICAL CIRCUIT PARAMETERS (R – resistance; C – capacity; L – inductivity) AND COEFFICIENT OF ELECTROACOUSTIC EFFICIENCY (η_{ea}) OBTAINED FROM THE INPUT ELECTRICAL IMPEDANCE MEASURED IN THE AIR AND IN THE ANECHOIC TANK AT DIFFERENT IMMERSION DEPTHS ($d = \lambda/4; \lambda/2; \lambda$) AT RESONANCE FREQUENCY (f_s)

	f_s [Hz]	R [Ω]	L [H]	C [pF]	η_{ea} [%]
Air	24775	570.43**	2.50	0.16	–
Water-FF*($d=\lambda/4$)	24665	1110	2.55	0.16	46.19
Water-FF*($d=\lambda/2$)	24668	1092	2.55	0.163	45.99
Water-FF*($d=\lambda$)	24662	1186.8	2.61	0.159	50.23

*FF – free acoustic field (anechoic tank)

** – in the air there is only air vibrating with the sonotrode tip and the energy is not radiated so the resistance in the equivalent electrical circuit represents only mechanical losses

d[m] – immersion depth

λ [m] – wavelength of ultrasound wave in water at excitation frequency of 25 kHz ($\lambda = 6$ cm)

when the tip displacement is negligible and the input electrical impedance is much larger compared to the value obtained at series resonance frequency of the longitudinal vibration mode.

When the input electrical impedance measurement around series resonance frequency is done (see Table 1), connections between the equivalent electrical circuit (RLC) parameters and acoustical behaviour of transducer are made¹⁴.

Method for measuring derived acoustic power in the anechoic tank

Setup for measuring the derived acoustic power is shown in Fig. 5. The sonotrode tip is immersed at $d = \lambda/4$ (where $\lambda = 6$ cm in water at excitation frequency of $f = 25$ kHz). The hydrophone is moved along z-axis where the pressure magnitude spatial distribution is measured (Fig. 5). Two different operating modes are considered: linear and nonlinear. In the linear operating mode there is no cavitation activity in front of the sonotrode tip. Measurements in linear operating mode serve to calibrate the system and convert power spectral density units (dB/Hz) into pressure units (dB(Pa)). In the nonlinear operating mode, the strong acoustic cavitation activity is present in front of the tip (Fig. 6). The bubbles of air produced by process of cavitation in the water oscillate in the primary acoustic field^{8,15} (Fig. 6).

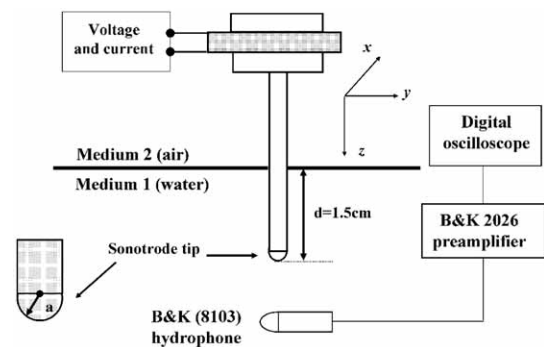

Fig. 5. Measurement setup for measuring the derived acoustic power.

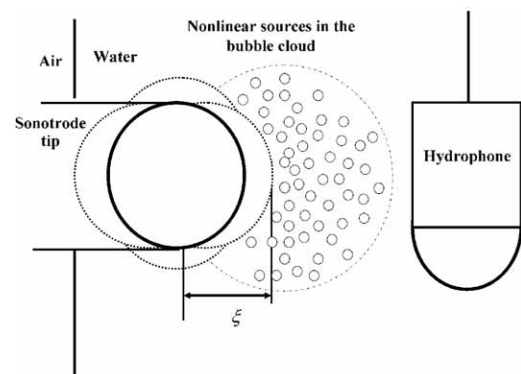

Fig. 6. Sonotrode tip and the bubble cloud produced in front of the tip in the nonlinear operating mode.

In both operating modes, the pressure magnitude spatial distribution is measured by hydrophone, charge pre-amplifier and digital storage oscilloscope. Derived acoustic power is calculated using curve fitting with theoretical model of point ultrasound source, as described in literature^{16,17}. The coefficient of electroacoustic efficiency (η_{ea}) of this method is defined as a ratio of the derived acoustic power (P_d) at excitation frequency (25 kHz) and RMS (root mean squared) electrical power (P_{EL}). Calculated values ($\eta_{ea}=P_d/P_{EL}$) from experimental data are presented in Table 2.

TABLE 2
DERIVED ACOUSTIC POWER (P_d) AND COEFFICIENT OF ELECTROACOUSTIC EFFICIENCY (η_{ea}) AT EXCITATION FREQUENCY (25 kHz) OBTAINED AT DIFFERENT APPLIED ELECTRICAL POWER LEVELS (P_{EL})

P_{EL} [W]	P_d [W]	ΔP_d [W]	η_{ea} [%]
0.65	0.261	0.022	40.02
1.37	0.592	0.052	43.51
1.85	0.451	0.092	23.92
3.01	0.322	0.047	10.70
5.32	0.451	0.096	8.48
6.35	0.306	0.072	4.81
8.12	0.436	0.031	5.37
9.07	0.489	0.031	5.39
11.11	0.503	0.029	4.53
13.29	0.510	0.041	3.84
15.13	0.436	0.048	2.88

ΔP_d [W] – standard deviation of measured derived acoustic power

Method for calorimetric measuring of output acoustic power

Calorimetric method can be used for measurement of the dissipated acoustic power in a restricted volume of liquid, produced by an ultrasound device^{18–23}. The sonotrode tip and temperature sensor were inserted into a calorimeter containing a loading medium (water) (Fig. 7). We used two calorimetric system setups (Calorimeter-1 and Calorimeter-2), with different box masses and associated water amount namely calorimeters with different total heat capacities (Table 3).

The rate of the temperature rise of the absorbing fluid was determined and used to calculate the acoustic power released by the sonotrode. In the calorimetric experimental setups used in the measurement system, temperature is changed due to absorption of energy into all

TABLE 3
TOTAL HEAT CAPACITY (C_{sys}) OF TWO CALORIMETRIC CONFIGURATIONS (CALORIMETER-1 AND CALORIMETER-2)

	Calorimeter-1	Calorimeter- 2
C_{sys} [J/(°C)]	212.37	426.10

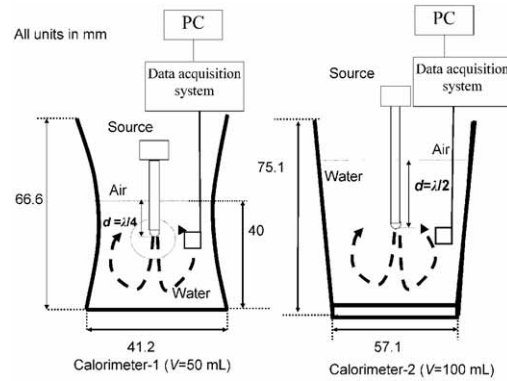

Fig. 7. Calorimetric setups used in measurement of output acoustic power.

parts of the system (mass of liquid, calorimeter parts and measurement equipment). The equation describing the change of internal energy in the system due to absorbing ultrasound waves in the liquid volume is given as:

$$\Delta U = \Delta Q = \sum_{i=1}^N m_i \cdot c_i \cdot \Delta T \tag{2}$$

where

ΔU [J] – change of the total internal energy in the calorimetric system,

ΔQ [J] – amount of heat energy delivered to the calorimetric system,

m_i [kg] – mass of each part of calorimetric system (calorimeter, sonotrode, temperature sensor),

c_i [J/(kg °C)]– specific heat capacity of each part of the calorimeter system,

ΔT [°C] – temperature change in the system,

N – number of calorimeter system elements.

The dominant part of the calorimeter system is the mass of water, as it absorbs the majority of ultrasound energy. By multiplying masses and associated specific heat capacities, and adding them together, the total heat capacity (C_{sys}) of the calorimeter is obtained:

$$C_{sys} = \sum_{i=1}^N m_i \cdot c_i \tag{3}$$

By measuring the temperature increase (ΔT) in the associated time interval (Δt) and using equation (4), the output acoustic power (P_d) of an ultrasound device can be determined. The measurement duration was 3 minutes and the measured temperature has been fitted with the theoretical linear curve in the first minute of measurement.

$$P_a = \frac{\Delta Q}{\Delta t} = \sum_{i=1}^N m_i \cdot c_i \cdot \frac{\Delta T}{\Delta t} = C_{sys} \cdot \frac{\Delta T}{\Delta t} \tag{4}$$

The calorimetric method is used at higher excitation levels and cavitation activity in front of the tip causes acoustic streaming which ensures homogenous temperature distribution in the calorimeters. The coefficient of electroacoustic efficiency of the device in this method (η_{ea}) is calculated as a ratio of the output acoustic power

TABLE 4
THE OUTPUT ACOUSTIC POWER (P_a) AND ELECTROACOUSTIC EFFICIENCY (η_{ea}) OBTAINED AT DIFFERENT ELECTRICAL LEVELS (P_{EL}) IN TWO DIFFERENT CALORIMETRIC CONFIGURATIONS (Calorimeter-1 and Calorimeter-2) AT DIFFERENT IMMERSION DEPTHS ($d=\lambda/4$ AND $\lambda/2$)

A) CALORIMETER-1			
Configuration	P_{EL} [W]	P_a [W]	η_{ea} [%]
CAL-1, $d= \lambda/2$	3.05	2.63	86.23
CAL-1, $d= \lambda/4$	2.62	2.1	80.15
CAL-1, $d= \lambda/2$	3.91	3.29	84.14
CAL-1, $d= \lambda/4$	3.62	3.03	83.70
CAL-1, $d= \lambda/4$	5.63	4.65	82.59
CAL-1, $d= \lambda/2$	7.22	5.88	81.44
CAL-1, $d= \lambda/4$	6.83	5.46	79.94
CAL-1, $d= \lambda/2$	8.55	7.01	81.99
CAL-1, $d= \lambda/4$	8.74	7.30	83.52
B) CALORIMETER-2			
Configuration	P_{EL} [W]	P_a [W]	η_{ea} [%]
CAL-2, $d= \lambda/2$	5.56	4.72	84.89
CAL-2, $d= \lambda/4$	5.43	4.53	83.43
CAL-2, $d= \lambda/2$	5.93	4.93	83.14
CAL-2, $d= \lambda/2$	7.08	5.68	80.23
CAL-2, $d= \lambda/4$	7.17	5.67	79.08
CAL-2, $d= \lambda/2$	8.54	6.93	81.15
CAL-2, $d= \lambda/4$	8.56	7.01	81.89

(P_a) and RMS (root mean squared) value of the electrical power (P_{EL}). Values calculated ($\eta_{ea}=P_a/P_d$) from experimental data are presented in Table 4.

Results

Using the method for the sonotrode tip displacement measurement, we observed a maximal tip displacement around 100 μm (Fig. 8). It has a similar value in the air and in the water. There is no analytical equation which will connect the measured tip displacements and radiated acoustic power. It is evident approximately square root dependence of the tip displacement and input elec-

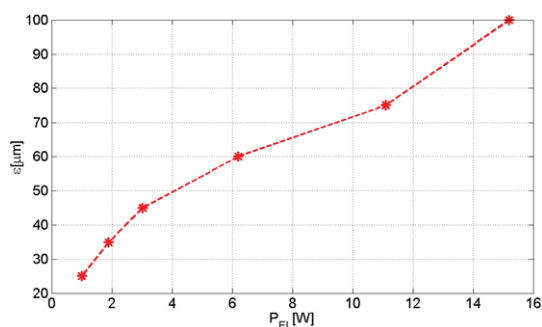

Fig. 8. Tip displacement vs. applied RMS electrical power measured in the air.

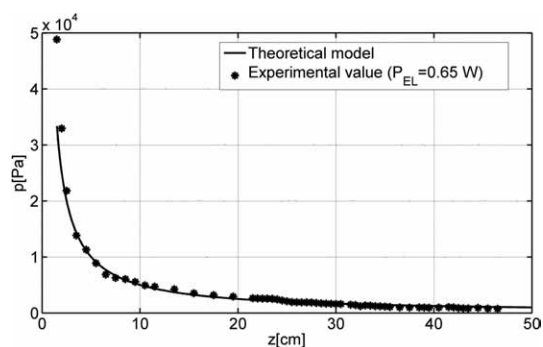

Fig. 9. Comparison between measured and theoretical results for pressure magnitude spatial distribution.

trical power as the characteristic behaviour of harmonic oscillator. In Table 1, we can see equivalent electrical circuit parameters (R , L , and C) of the device input electrical impedance measured in the air and in the water in the anechoic tank at three different immersion depths. The coefficient of electroacoustic efficiency (η_{eaEQ}) is immeasurable in the air due to high attenuation of the ultrasound waves propagation through the air. In the water, the value of coefficient η_{eaEQ} does not change significantly (from 46.2% up to 50.2%) at immersion depths considered (Table 1). When the applied electrical power on piezoceramic elements is $P_{EL}=0.65$ W (Table 2), the cavitation effect is not present in front of the sonotrode tip.

In experiments for measuring the derived acoustic power (P_a), the electroacoustic efficiency factor is around 40%. If excitation frequency is considered, the measured spatial distribution corresponds with the theoretical model¹⁶ (as shown in Fig. 9).

In the case of larger electrical power levels applied (for example $P_{EL}=5.35$ W), the cavitation activity is present in front of the sonotrode tip and the pressure signal recorded in the far acoustic field consists of multiple frequency components (see Fig. 10). This suggests that the coefficient of electroacoustic efficiency η_{ea} calculated for excitation frequency (Table 2) should decrease (from 40% to 2.9%) due to energy dispersion.

The output acoustic power has been measured using calorimetry in different configurations (Calorimeter 1 and Calorimeter 2) with different geometry and total heat capacities, and the results are shown in the Table 4. In all measurements, the sonotrode tip is located in the

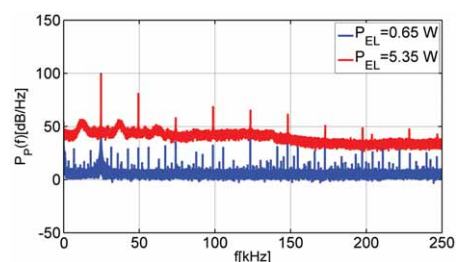

Fig. 10. Pressure signal power spectral density ($P_p(f)$) at different excitation levels and same distance from the sonotrode tip ($r=1\text{cm}$).

centre of the configuration (Fig. 7). It can be seen that the output acoustic power increases (from 2.1 to 7.3 W) linearly with applied electrical power P_{EL} (Table 4), and slightly depends on the sonotrode tip immersion depth. It can be seen that measured output acoustic power is slightly larger when the immersion depth of the sonotrode is $\lambda/2$ due to larger effective area of the device. The electroacoustic efficiency factor (η_{ea}), is approximately 80% in all measurement setups, as shown in Table 4.

Discussion

NECUP-2 is being used for neurosurgical procedures on experimental animals²⁴ and in patients with different neuropathological diseases such as hydrocephalus and tumours²⁵. However, the correlation between biological effects (destruction of pathological and normal tissue) and the acoustic power applied to the tissue is still unknown. Namely, the determination of acoustic power of the ultrasound device during the process of cavitation is not well described in literature⁷. In this study, we have tested all available methods recommended by IEC 61847 Standards for determination of the acoustic parameters of the neurosurgical ultrasound device.

As it can be seen from our results, for each of three methods shown, the different values of the acoustic power of the tested ultrasound source are obtained at the different acoustic loading conditions (e.g. in air and water, with or without cavitation). One should be cautious in comparison of these results, due to the facts that the output acoustic power is measured in the strong nonlinear mode, and the input electrical impedance can be measured only in the linear operating mode without cavitation. Measuring the derived acoustic power produced by the probe in the anechoic tank, we have obtained a significant difference between the coefficient of electroacoustic

efficiency determined in the linear operating mode (η_{ea} 40%, for $P_{EL} < 1.37$ W; Table 2) and the one obtained in the nonlinear operating mode ($\eta_{ea} < 24\%$ for $P_{EL} > 1.8$ W; Table 2; area of cavitation process) at excitation frequency. However, there is no significant difference in the electroacoustic efficiency factor derived from the equivalent electrical circuit approach (Table 1) and the one obtained measuring the derived acoustic power in the anechoic tank when there is no cavitation activity ($P_{EL} = 0.65$ W) (Table 2).

In order to make better comparison between the derived and output acoustic power we should calculate the total derived acoustic power radiated from all sources present in the bubbles' cloud in front of the sonotrode tip. Namely, during the cavitation process, each bubble becomes a new source of the ultrasound which is excited with primary excitation field. These new sources of ultrasound become detectible during the measurement of the power spectral densities of pressure signals recorded in the anechoic tank (Fig. 10). In Fig. 10, these new sources are presented as subharmonics, harmonics and ultraharmonics of excitation frequency (shown as peaks in the curve of power spectral density).

In presented measurement, the derived acoustic power is determined only at excitation frequency of 25 kHz which provides the maximal peak of power spectral density (Fig. 10). The sonotrode tip displacement is determined in the air and in the water.

In the further investigations, the sonotrode tip displacement analyzed here should be compared with the displacements measured in different loading mediums which have same neurosurgical conditions. Investigation of the physical properties of ultrasound effects in laboratory conditions generated by these types of ultrasound sources provides opportunity for better understanding of biological effects in different surgical treatments.

REFERENCES

1. FRY WJ, DUNN F, Journal of the Acoustical Society of America, 29 (1957) 1374. — 2. ERIKSON KR, FRY FJ, JONES JP, IEEE Transactions on Sonics and Ultrasonics, SU 21 (1974) 144. — 3. BOND LJ, CIMINO WW, Ultrasonics, 34 (1996) 579. — 4. CIMINO WW, BOND LJ, Ultrasonics in Medicine and Biology, 22 (1996), 89. — 5. PACKER M, FISHKIND WJ, FINE IH, SEIBEL BS, HOFFMAN RS, Journal of Cataract and Refractive Surgery, 31 (2005) 424. — 6. BONI L, BENEVENTO A, CANTORE F, DIONIGI G, ROVERA F, DIONIGI R, Expert Review of Medical Devices, 3 (2006) 147. — 7. INTERNATIONAL STANDARD IEC 61847, Ultrasonics-Surgical systems, Measurement and declaration of the basic output characteristics, Geneva-Switzerland, International Electrotechnical Commission, (1998). — 8. LEIGHTON T, Acoustic bubble (Academic Press, San Diego, 1994). — 9. PETOŠIĆ A, Evaluating acoustic parameters of an ultrasound point in the linear and nonlinear operating mode, Ph. D. Thesis, In Croat (Faculty of Electrical Engineering and Computing, University of Zagreb, Zagreb, 2008). — 10. PARLITZ U, METTIN R, LUTHER S, AKHATOV I, VOSS M, LAUTERBORN W, Philosophical Transactions of the Royal Society of London Series A-Mathematical Physical and Engineering Sciences, 357 (1999) 313. — 11. ŠTIMAC T, AMBRUŠ D, SVILAR D: NECUP-2, elaborat, Center for Clinical Research in Neuroscience, School of Medicine University of Zagreb and Croatian Institute for Brain Research, Zagreb, Croatia (2004), 30. — 12. ŠTIMAC A, Evaluating ultrasound point source parameters for minimally invasive surgery, Ph. D. Thesis, In Croat (Faculty of Electrical Engineering and Computing, University of Zagreb, Zagreb, 2004). — 13. MORTIMER B, DUBRUYN T, DAVIES J, TAPSON J, Ultrasonics, 39 (2001) 257. — 14. IN-

15. INTERNATIONAL STANDARD CEI, IEC 61088, Characterization and measurements of ultrasonic piezoceramic transducers, Geneva-Switzerland, International Electrotechnical Commission, (1991). — 15. GAITAN DF, CRUM LA, CHURCH CC, ROY RA, Journal of the Acoustical Society of America, 91 (1992) 3166. — 16. PETOŠIĆ A, IVANČEVIĆ B, SVILAR D, Ultrasonics, 6 (2009) 522. — 17. SCHAFFER ME, BROADWIN A, Acoustical characterization of ultrasonic surgical device In proceedings (IEEE Ultrasonic symposium, IEEE Inc., New York, (1994), 1903. — 18. CAMPOS-POZUELO C, GRANGER C, VANHILLE C, MOUSSATOV A, DUBUS B, Ultrasonics Sonochemistry, 12 (2005) 79. — 19. ŠTIMAC A, KOMESTIĆ V, ŠTIMAC T, An approach to calibration of ultrasonic surgery equipment In Proceedings (8-th International IMEKO TC-13 Conference on measurement in clinical medicine, Dubrovnik, Croatia, 1998). — 20. ZIENIUK JK, EVANS B, Acustica, 25 (1971) 48. — 21. MARGULIS IM, MARGUILIS MA, Acoustical Physics, 51 (2005) 695. — 22. MARGULIS MA, MARGULIS IM, Calorimetric method for measurement of acoustic power absorbed in a volume of a liquid, Ultrasonics Sonochemistry, 10 (2003) 343. — 23. PETOŠIĆ A, ŠTIMAC T, SVILAR D, Ultrasonic power measurements in the nonlinear regime using calorimetry method, In Proceedings (Alpe Adria Acoustics Association Conference, Graz, 2007). — 24. ŠTIMAC D, Učinak ultrazvučnog aspiratora na neuralno tkivo, Ph. D. Thesis, In Croat (School of medicine, University of Zagreb, Zagreb, 2004). — 25. JEDNAČAK H, PALADINO J, MIKLIĆ P, VUKIĆ M, KLARIĆA M, The usage of new ultrasonic microprobe in neuroendoscopy, Clinical Neurology and Neurosurgery, Meeting Hydrocephalus 2008, Hannover, Germany, 17-20.09.2008.

A. Petošić

*University of Zagreb, Faculty of Electrical Engineering and Computing, Unska 3, Zagreb, Croatia
e-mail: antonio.petosic@fer.hr*

METODE ZA MJERENJE AKUSTIČKE SNAGE IZVORA ULTRAZVUKA U NEUROKIRURGIJI

S A Ž E T A K

Mjerenje akustičke snage visoko-energetskih ultrazvučnih izvora je složeno zbog pojave kavitacije ispred vrha sonotrode. Uobičajeno je koristiti samo jednu metodu za mjerenje izlazne akustičke snage, međutim u ovome istraživanju su primjenjene i uspoređene sve tri preporučene metode vrednovanja ultrazvučnog izvora. Prva metoda se temelji na karakterizaciji pretvarača i sastoji se od mjerenja pomaka sonotrode i ulazne električne impedancije oko pobudne frekvencije s različitim razinama privedene električne snage. Druga metoda se temelji na mjerenju prostorne raspodjele magnitude tlaka ultrazvučnog izvora u »gluhom« bazenu. Princip akustičkog reciprociteta se koristi za određivanje isijane akustičke snage ekvivalentnih izvora na frekvencijskim komponentama prisutnim u spektru ultrazvučnih valova. Treća metoda se temelji na kalorimetrijskom mjerenju apsorbirane akustičke snage u vodi. Elektromehaničkom karakterizacijom sonotrode dobivena je vrijednost elektroakustičkog koeficijenta iskorištenja od 40% do 60% što je približno jednako vrijednosti dobivenoj mjerenjem isijane akustičke snage u »gluhom« bazenu u linearnom načinu rada sonotrode kada nema kavitacije. Kada je prisutna kavitacijska aktivnost ispred vrha sonotrode, nastali oblak mjehurića značajano smanjuje isijanu akustičku snagu. Izlazna akustička snaga dobivena kalorimetrijskom metodom je veća od isijane akustičke snage izmjerene ostalim metodama. U budućim istraživanjima mjereni akustički parametri će se povezati s biološkim učincima u neuralnom i drugim tkivima.